

# Hybrilux

## SL35 SMART SOLAR SAIL

### All-in-One Smart Solar LED Street Light

A full range solar street luminaire with flexibility, low maintenance and with advanced iNet smart control system.



20-90W



220lm/W



IP66



LifePO4



Timer dim



Mono-crystalline Silicon Panel



32°F to +140 °F



PIR Sensor



Sustainable



IK08



MPPT



High flexibility



### Elegant Solar Lighting Powered by Intelligent IoT Technology

Harnessing the power of the sun, the Smart Solar Sail is an advanced all-in-one solar lighting system designed to illuminate streets, pathways, and public spaces without the need for electrical infrastructure. Its sleek design integrates a high-efficiency solar panel, large lithium battery, and high-performance LED engine to deliver reliable illumination.

With built-in IoT connectivity, each luminaire can be remotely monitored to track performance, verify operation, and enable proactive maintenance.

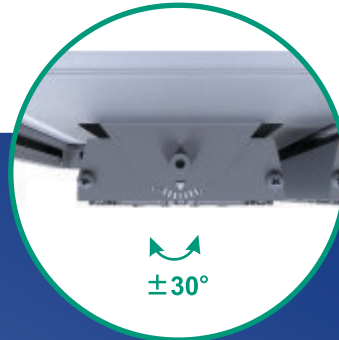

±30°

Wide-angle  
adjustability



Anti-roosting  
spikes available



±90°



### Applications

- Street Lighting
- Roadway Lighting
- Pathway Lighting
- Ramp Lighting
- Sidewalk Lighting
- Private Road Lighting
- Farm Lighting
- Wildlife Area Lighting
- Perimeter Security Lighting
- Park Lighting
- Railway Yard Lighting
- Fence Lighting
- Campus Lighting
- Ship Dock Lighting
- Remote Area Lighting
- Military Base Lighting
- Gate Lighting
- Jogging Path Lighting

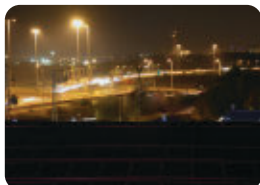

### Proven Reliability. Exceptional Value.



Only top quality mono - crystalline silicon solar panels with high efficiency and long lifetime are used.



High-quality lithium batteries store solar energy to deliver dependable power when needed, while providing multiple days of backup operation during cloudy or low-sun conditions



High-efficacy LEDs deliver powerful illumination with maximum energy efficiency. A dedicated low-voltage solar controller with intelligent dimming optimizes power management and extends system operating autonomy. LEDs are rated for 50,000+ hours with a nominal CRI of 70.



Microprocessor-controlled algorithms automatically detect sunrise and sunset for optimized lighting operation.



Easy installation with no trenching, wiring, or external power supply required. Direct pole mounting with an adjustable spigot (0°–90°).

### What our fixtures and system can do

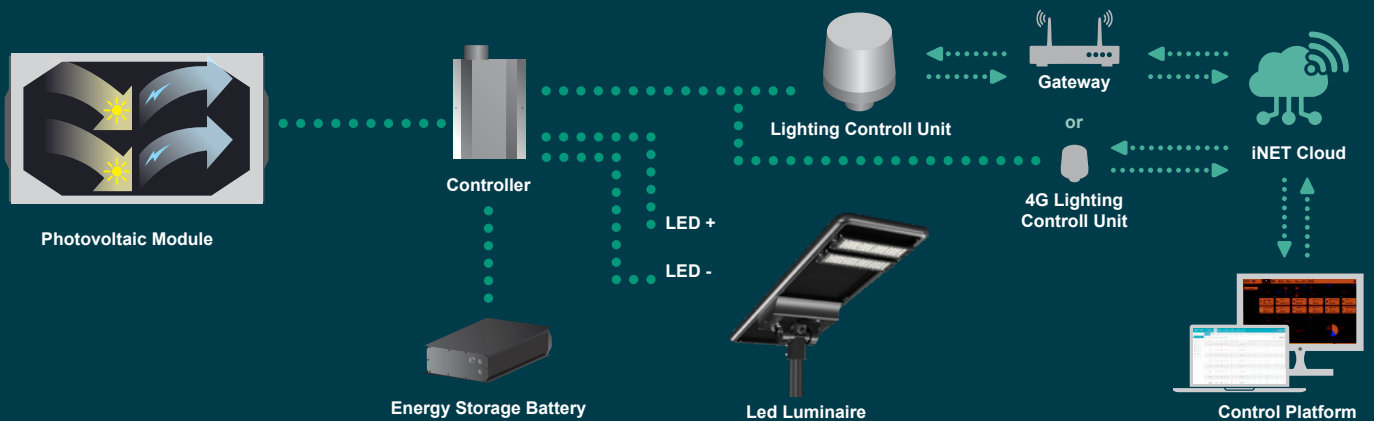

The entire lighting system is guaranteed for 5 years and the 10 years guaranteed for battery maintenance.

Premium-grade Integrated All-in-one Design, Easy to Install and Maintain.

Light on/off and dimming programmable smart light.

Zero carbon emission

No Trenching or Cabling Work Needed.

Using Grade A+ battery cell, the battery cycle life more than 4000 times.

High Luminous Efficiency of 210~220lm/W to Maximize Battery Performance.

Pivoting LED Modules Deliver the Best Lighting Control.

IP66 Luminaire Ensures Long Lasting and Consistent High Performance.

24-7 battery life monitoring, battery life cycle reminder, work report.

Built-in GPS Tracking for Product Security

Remote Real-time Monitoring and Management

Powerful Data Collection and Analysis Functions

Precise Battery Monitoring

AI Enabled Pole/Light Tilt Alarm

Flexible and Adjustable Work Mode

Seamless Integration of Charge Controllers with IoT System

### Smart Anti-Theft Design

#### Real-Time Geo Tracking

The real-time mini Geo anti theft tracking device is fitted in an un-accessible location of the solar street light fixture, which is permanently powered to enable security recovery teams to track and locate the solar lights anywhere via the live app to recover the product and arrest the thieves as long as the solar light battery has power.



0000000000  
GPS  
Status: Move  
Time: 08:00:13  
Direction: East  
Mileage: 2  
70,51km

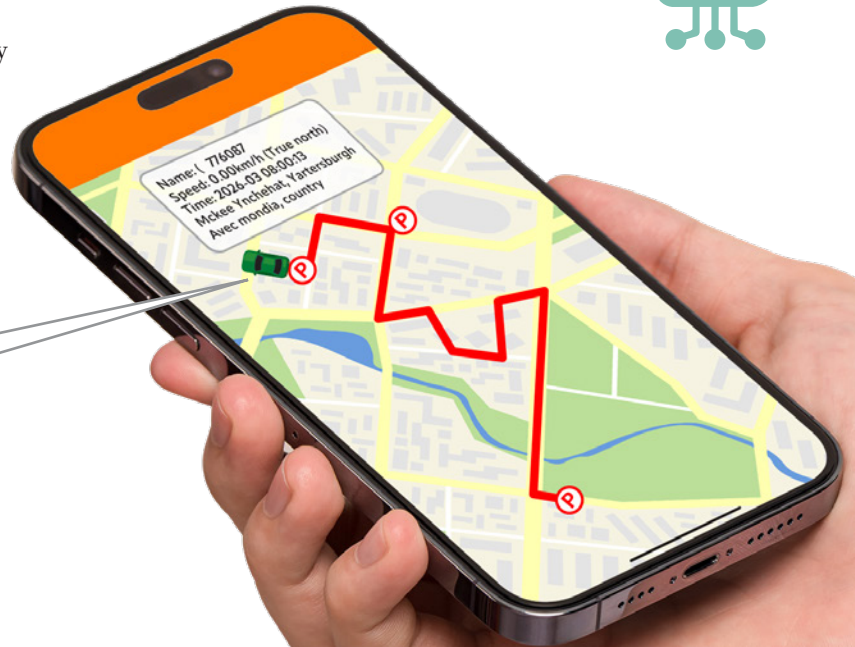

#### AI Enabled Pole/Light Tilt Alarm

When the solar lights go on wireless IoT smart management system, sophisticated AI algorithm based on gyroscope and accelerometer data intelligently locks the lights' angle upon installation, any unauthorized attempt at theft or tampering will be detected, alarms will be activated at the Operation Center and alert text message will be instantly sent from Central Management Platform to the security teams.

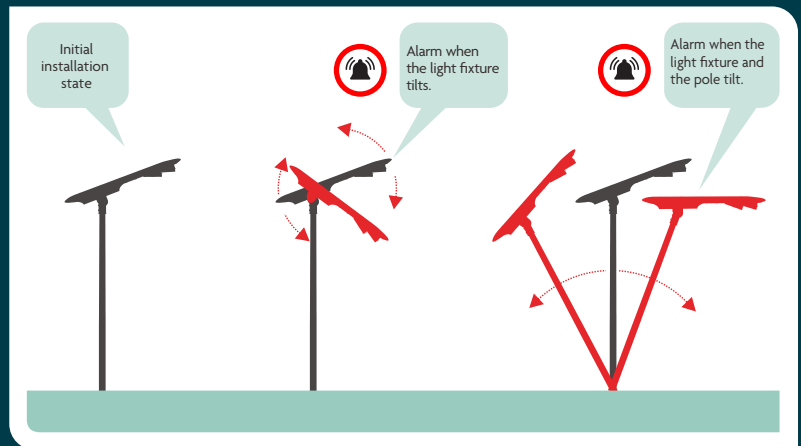
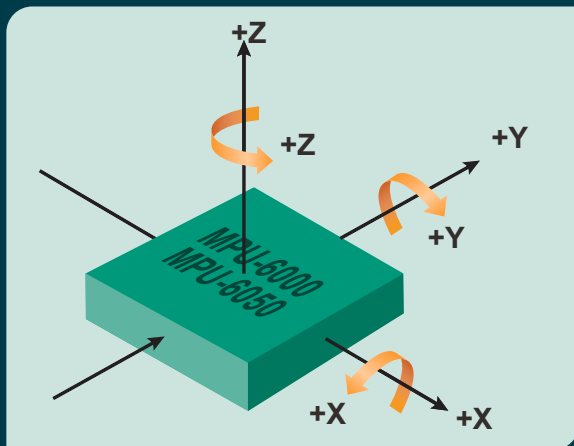

### Precise Battery Status Monitoring

The solar light features a high-precision coulometer, also known as a coulomb meter, which provides accurate readings on battery performance by measuring its current. It can detect and display, in real-time, the battery's voltage, current, power, actual capacity, remaining time, and other key parameters, ensuring you have an accurate understanding of the battery's status at all times

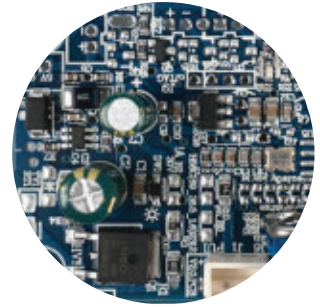

### Stay Powerful The DC Charge Port

A DC charge port is offered as an option to be integrated into Smart Solar Sail, ensuring the battery remains charged even during extended periods in the warehouse. No more worrying about flat batteries when you need them the most. Embrace the continuous and dependable lighting with our state-of-the-art Smart Solar Sail street light



### Built to Last

Our Smart Solar Sail fixtures and poles are engineered using premium-grade materials to ensure long-lasting durability and reliable, maintenance-free performance. They deliver a high-quality off-grid lighting solution designed for efficiency, sustainability, and years of dependable operation.

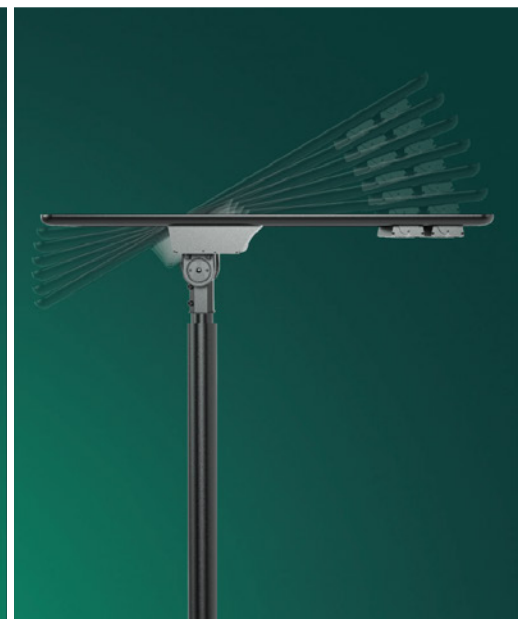

### Mono Solar Panel



#### Higher Durability

The multi-busbar design can decrease the risk of the cell micro-cracks and fingers broken.

$$+ \frac{W}{m^2}$$

#### High Power Density

High conversion efficiency 23% and more power output persquare meter, by lower series resistance and improved light harvesting.



#### PID Resistant

Tested in accordance to the standard IEC 62804, our PV modules have demonstrated resistancea against PID (Potential Induced Degradation), which translates to security for your investment.



#### Bigger Cells with better performance

A slight increase of the size of our cells, Boosts the performance of the newest modules by six percent on average.



#### First-class Quality Assurance

-10-year warranty for material and technology.  
-25-year linear power output warranty.

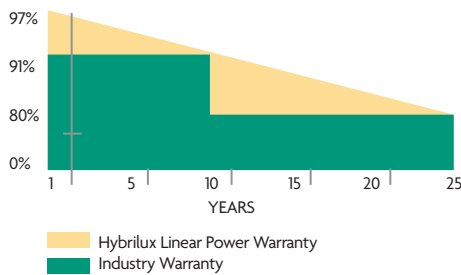

Specifications			
Maximum Power (Pmax/W)	55	75	105
Open Circuit Voltage(Voc/V)	22.8		43.2
Short Circuit Current(Isc/A)	3.25	4.31	3.15
Maximun Power Voltage(Vmp/V)	18V		36V
Maximum Power Current(Imp/A)	3.1	4.2	2.9
Module Efficiency (%)	24		
Output Tolerance (%)	±3		
Operating Temperature	40°F±104°F		
Wind Load/Snow Load	2400pa/5400pa		
NOCT	113±35°F		
Temp Coefficient of Isc	+0.046%/°F		
Temp Coefficient of Voc	-0.275%/°F		
Tem Coefficient of Pmax	-0.350%/°F		

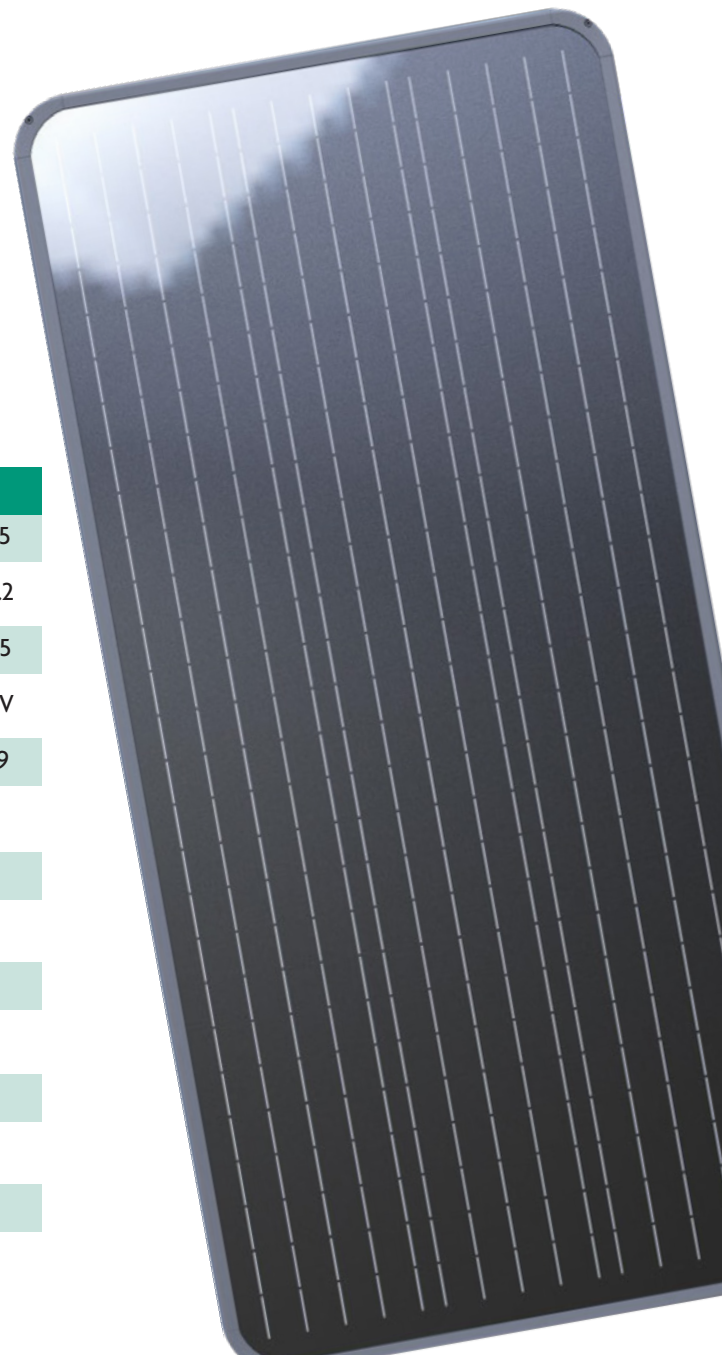

### High Performance Battery Pack Grade A+ Cell

LiFePO4 batteries have a higher energy density they can store more energy in a smaller and lighter package. This makes them ideal for applications where weight and space are a concern.

#### Advantage of LiFePO4

- A Long Lifespan
- No Active Maintenance
- Lightweight Champion
- High Efficiency
- Safety
- High Discharge Rates
- Extreme Temperatures
- Rechargeable Multiple Times



Specifications						
Capacity	12Ah	18Ah	24Ah	30Ah	24Ah	30Ah
Nominal Voltage	12.8V			25.6V		
Charging Voltage	14.6V			29.2V		
Load Voltage	≥12V			≥24V		
Standard Charging Method	5A(CC)charging to 14.6V; After CV(DC 14.6V) Charge until charging current≤0.02C			5A(CC)charging to 29.2V; After CV(DC 29.2V) Charge until charging current≤0.02C		
Charging Current	≥10A			≥20A		
Max Discharge Current	≥10A			≥20A		
Over Current	≥10A			≥20A		
Cut-Off Discharge Voltage	10V			20V		
Operating Temperature Range	LiFePO4: Charge:-20°C to 60°C / -4°F to 140°F Discharge:-20°C to 60°C / -4°F to 140°F)					
Storage	-4°F ~140°F					
Battery Category	LifePO4					
Cycle Life	≥4000					

#### LiFePO4 Battery

2000-5000 Cycles



5-10 Years life



2.5-12.8kg



Environmentally friendly





### Description

SL35 is a full range solar street light, five sizes cover 20W, 30W, 40W, 50W, 60W, 80W and 90W, well satisfy different applications. Smart control with built-in microwave motion sensor and timer dimming. Adjustable mounting angle, adjustable LED module and removable battery for easy installation, maintenance and replacement.

### Key Features

- All in one design, efficiency up to 220lm/W.
- Built in microwave motion sensor and timer dimming function
- Higher conversion Mono-crystalline photovoltaic solar panel.
- Luminaire size length and width can be customized.
- Solar panel and battery configurations can be customized.
- Easy maintainance with removable battery.
- LED module is adjustable.

### Applications

- Street Lighting
- Roadway Lighting
- Pathway Lighting
- Ramp Lighting
- Sidewalk Lighting
- Private Road Lighting
- Farm Lighting
- Wildlife Area Lighting
- Perimeter Security
- Park Lighting
- Railway Yard Lighting
- Fence Lighting
- Campus Lighting
- Ship Dock Lighting
- Remote Area Lighting
- Military Base Lighting
- Gate Lighting
- Jogging Path Lighting

### General Specifications

Solar Panel	Mono-crystalline
Wattage range	20W-90W
Lumen range	210-220lm/W
LEDs	Philips Lumileds
Control	MPPT / PWM Controller
Color Temperature	5000K (2500-6500K optional)
IES	60x100°/65x145/65x155°/70x135°/75x150°/80x150°/110°/150°
IP	IP66
IK	IK08
Battery	LifePO4 Battery
Extra Tools	Slip Filter
Operating Temperature	LiFePO4:Charge: -4°F to 140°F & Discharge: -4°F to 140°F)
Storing Temperature	-4°F to 140°F

### Fixtures Specifications

Model No.	SL35-20	SL35-30	SL35-40	SL35-50	SL35-60	SL35-80	SL35-90
Power	20W	30W	40W	50W	60W	80W	90W
Modules	1	1	1	1	2	2	2
Efficacy	4,200lm	6,100lm	8,000lm	10,000lm	12,300lm	16,000lm	18,000lm
Lumens	210lm/W	205lm/W	200lm/W	200lm/W	205lm/W	200lm/W	200lm/W
Solar Panel	55W/18V	55W/18V	55W/18V	75W/18V	75W/18V	105W/36V	105W/36V
Battery (Premium)	12.8V/18Ah	12.8V/24Ah	12.8V/24Ah	12.8V/30Ah	12.8V/30Ah	12.8V/24Ah	12.8V/24Ah

The solar panel and battery configuration is based on 6 hours charging time.

### Dimensions

Model No.	SL35-20	SL35-30	SL35-40	SL35-50	SL35-60	SL35-80	SL35-90
L x W x H (in.)	37.7"X 14.6"X 11.2"	37.7"X 14.6"X 11.2"	37.7"X 14.6"X 11.2"	50"X 14.6"X 11.2"	50"X 14.6"X 11.2"	46"X 21.6"X 11.2"	46"X 21.6"X 11.2"

### New Features

- IoT Monitoring
- Remote Control
- Add in Tilt Alarm
- GPS Tracking

\*Please consult with us for details on new features  
Please refer to individual part pages for a more detailed specification on each component.

EPA Value			
Model No.	Power	Horizontal Angle Solar Panel (#s)	EPA (ft <sup>2</sup> )
SL35-20 SL35-30 SL35-40	20W	0	0.31
		5	0.33
		10	0.67
	30W	15	0.99
		20	1.31
		25	1.62
		30	1.92
SL35-50 SL35-60	50W	0	0.36
		5	0.44
		10	0.88
	60W	15	1.31
		20	1.74
		25	2.14
		30	2.54
SL35-80 SL35-90	80W	0	0.53
		5	0.61
		10	1.21
	90W	15	1.80
		20	2.38
		25	2.94
		30	3.47

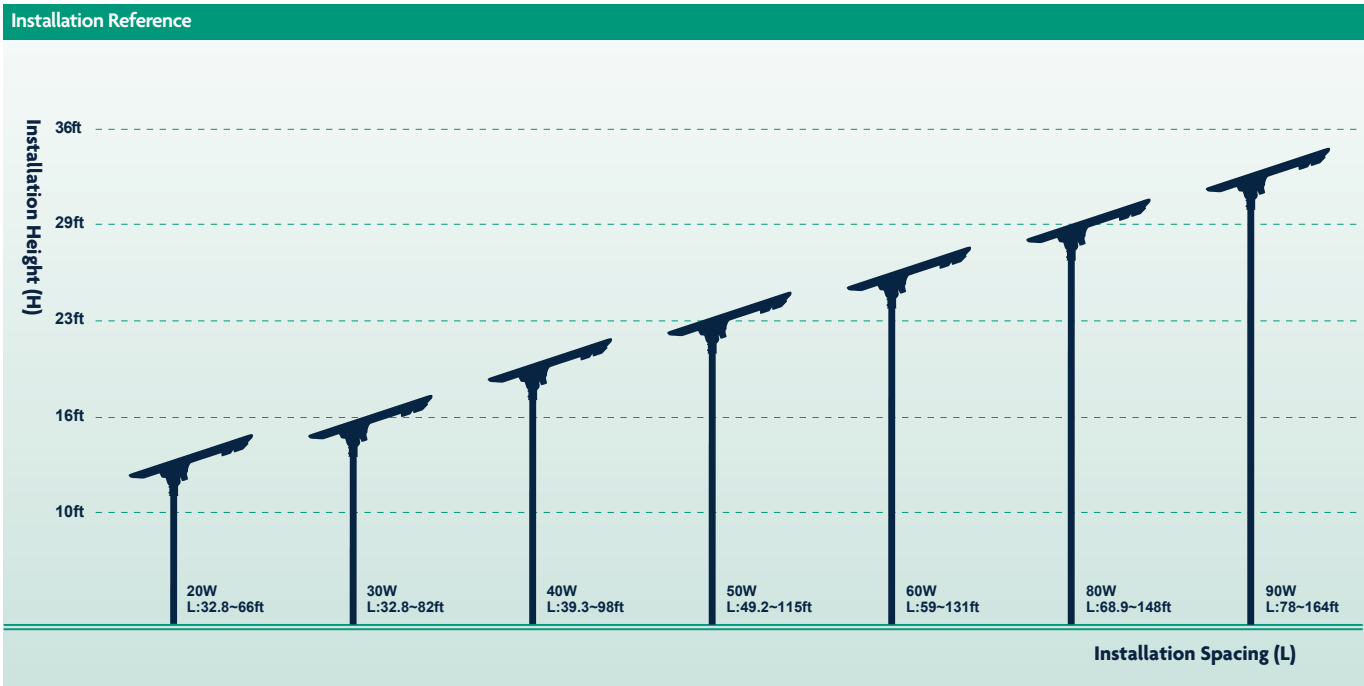

### Photometrics

60 X 100° Type I -VS

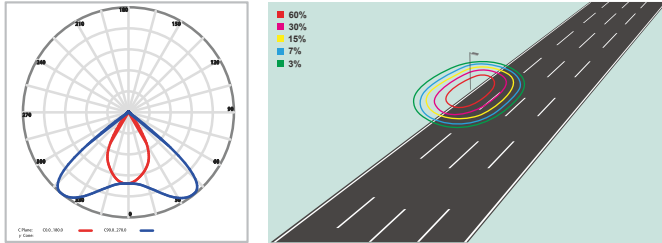

65 X 155° Type II -M

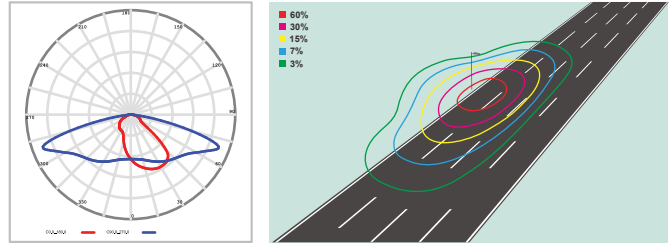

70 X 135° Type II -S

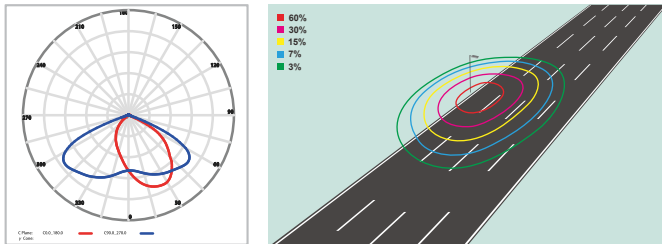

75 X 150° Type III -M

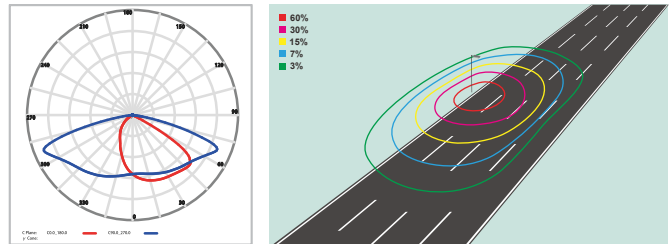

80 X 150° Type III -S

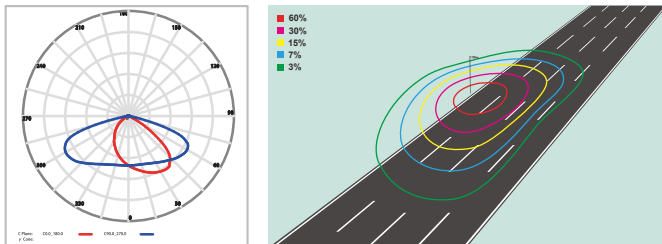

65 X 145° Type IV -S

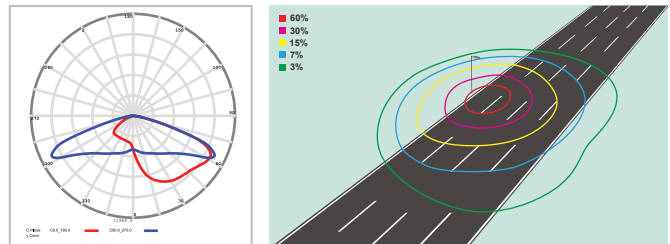

110 ° Type V -VS

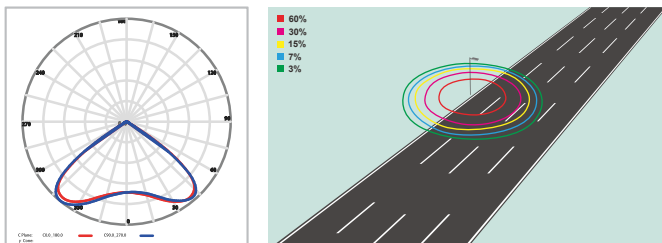

150° Type V -VS

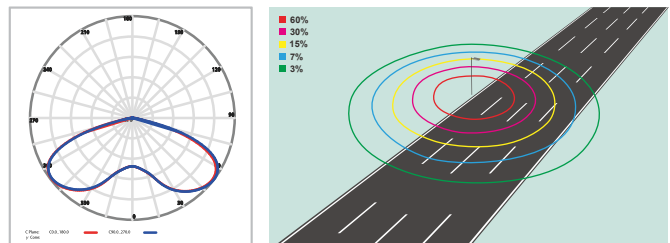

Default setting: 6m high Installation, 100% brightness.

### Solarsight Camera

#### 3MP H.265 4G Battery Camera

The Solarsight camera set up with 4G LTE network is a 100% wire-free rechargeable camera that delivers well rounded surveillance protection for up to almost 365 days on one single charge. With 2K, IP66 Weatherproof, the Solarsight camera provides a huge field of view so you can see every corner. Equipped with a built-in microphone and speaker, the outdoor camera allows you to listen and talk to anyone. Easy wireless installation-no need to connect your security camera to electrical wiring.



**3MP  
4G**



#### 3MP QHD Video

See more details than 1080p



#### Siren & Spotlight

Once an intruder is detected, the camera's spotlights and siren will be triggered or manually activated to warn off the would-be criminal



#### Two-way Talk

Using variable sound when taking real-time talk with people in front of the camera.



#### IP66

Weatherproof for outdoor conditions



#### 4G LTE Network

Operated on the 4G phone network to transmit image and video signals wirelessly.



#### PIR+Human Detection

Discerns people and motion detection for more accurate alerts.



#### Autotracking

Track moving targets in time.



#### Flexible & Secure Storage

Insert a micro SD card for local storage, (up to 256GB).



#### 1500mAh Rechargeable Battery

DC 5V Power Supply  
Rechargeable Battery Power.



#### Low Battery Notifications

Informs you when battery level goes down to 20%, 10%, so you can charge it in time.



#### Type C

Type C interface with better adaptability.



#### Works with Solar Panel

Battery charging through solar panel.

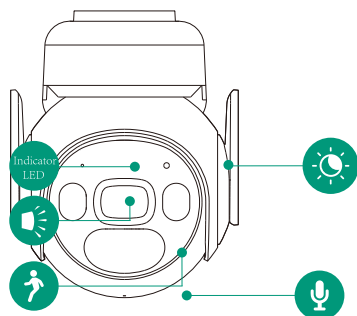

Front

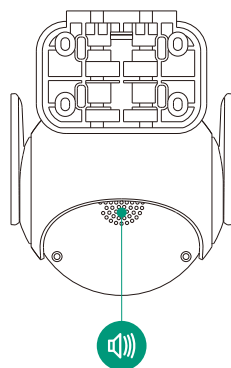

Back

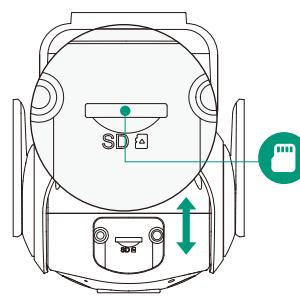

Back  
(opened door)

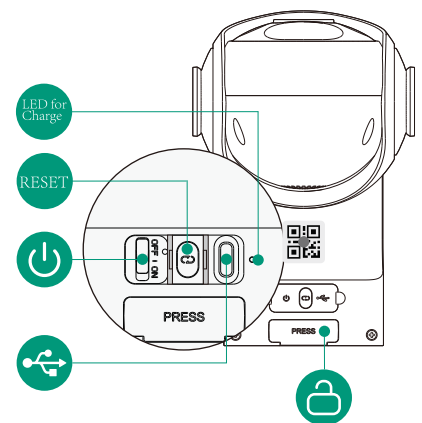

Bottom

### Regular MPPT Controller

The lamps lighting divide into 5 stage, each stage time and dim can be setting according to demands. With dimming setting, it is an efficient way to save energy, and keep the lamp working in best power and time.

### Five-Stage Mode

The lamps lighting divide into 5 stage, each stage time and dim can be setting according to demands. With dimming setting, it is an efficient way to save energy, and keep the lamp working in best power and time.

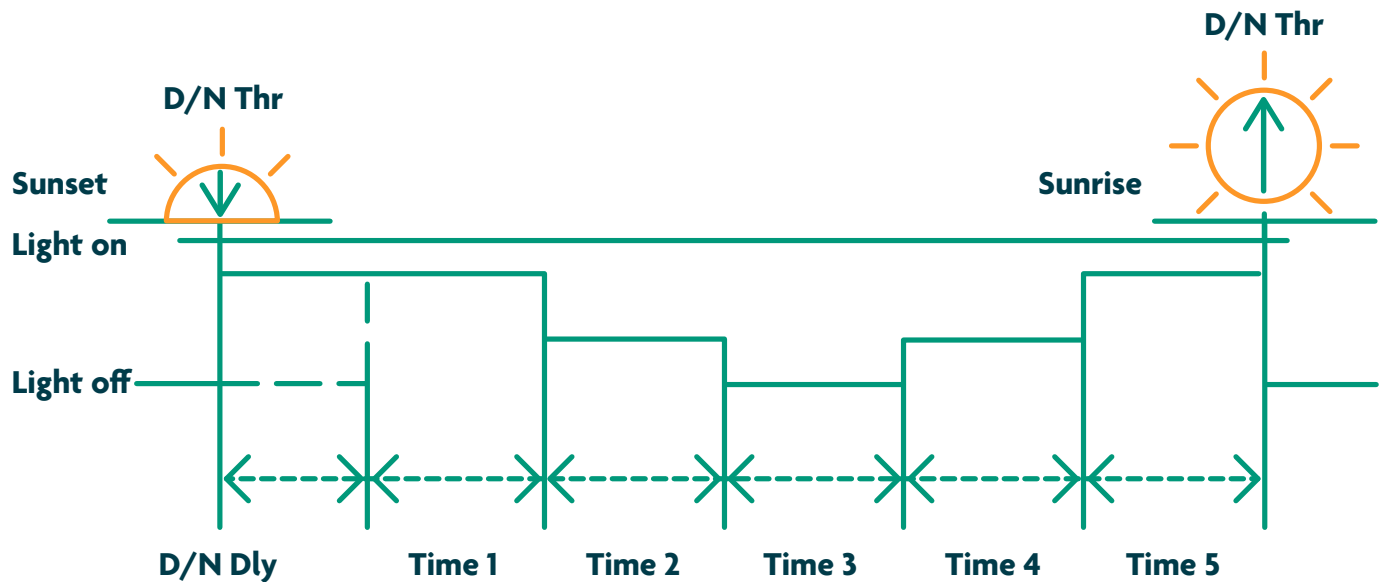

### Motion Sensor Mode

Motion: 2 hrs-100%; 3 hrs-60%; 4 hrs-30%; 3 hrs-70%;  
 Without Motion: 2 hrs-30%; 3 hrs-20%; 4 hrs-10%; 3 hrs-20%;

	2 hrs	3 hrs	4 hrs	3 hrs
Motion				
NO Motion				

### Hybrid MPPT Controller

#### Dusk to Dawn (D2D)

When fixture is set to D2D, it works in dusk to dawn mode. The fixture will turn on while the sun is down, as determined by the solar panel voltage.

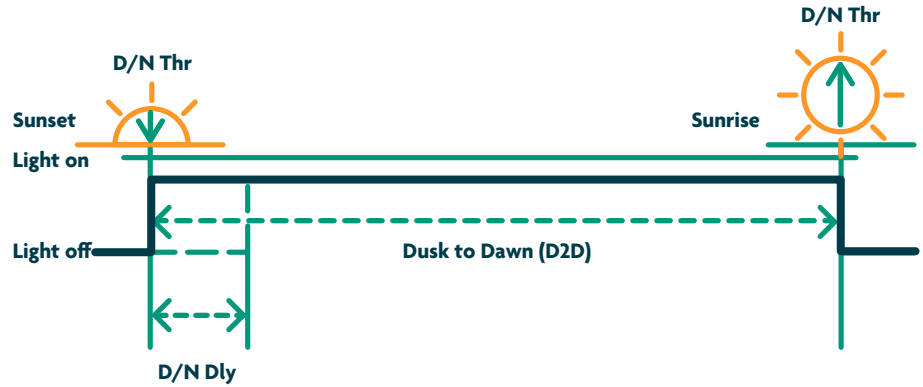

#### Five-stage Night Mode

The lamps lighting divide into 5 stage, each stage time and dim can be setting according to demands. With diming setting, it is an efficient way to save energy, and keep the lamp working in best power and time.

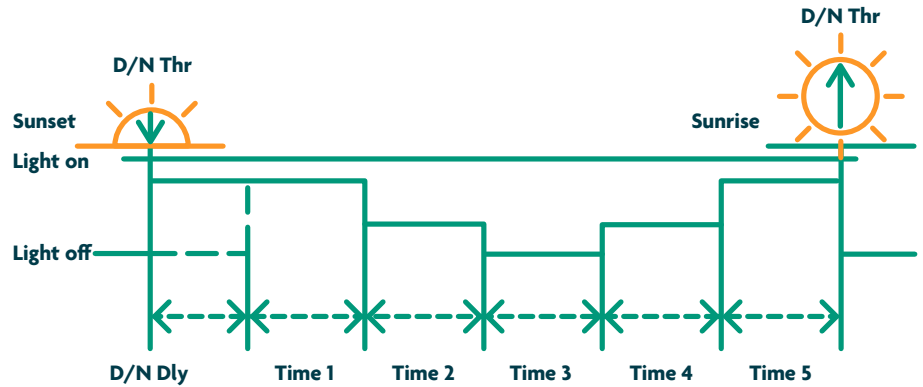

#### TOT Mode

(Can set the load on time before morning coming.)

When fixture is set to TOT then it will determine Time4 based on Time5 and previous data on the time of sunrise.

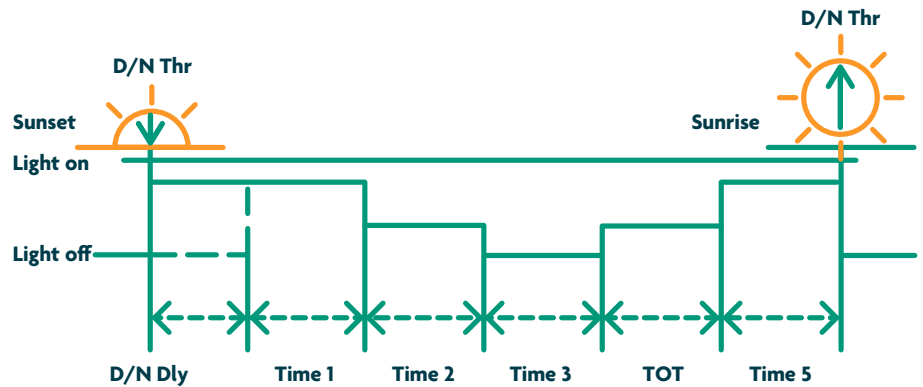

### MPPT Charge Controller

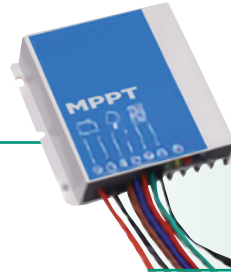

#### Features

- Innovative Max Power Point Tracking(MPPT) technology, tracking efficiency >99.9%
- Full digital technology, high charge conversion efficiency up to 97.5%, discharge conversion efficiency up to 96.5%
- Can output constant current (output current can be set)
- 5 stages time and dimming can be adjusted
- Can read parameters and running status
- If battery voltage is low, it can be set to dimming
- Dimming start voltage and percentage can be set
- Day/Night threshold can adjust automatically
- AGM, Liquid, GEL and Lithium battery for selection
- 32°F Charging Protection (Lithium)
- When BMS power off because of LVD, it can activate the system automatically
- Four stages charge way: MPPT, boost, equalization, float
- IP67, Strong and durable aluminum case Full automatic electronic protect function

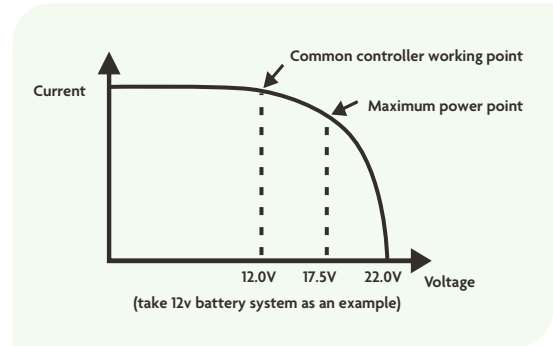

#### Indicator Functions

LED	Status	Function
Green LED	On	Solar panel is correctly connected, but not charged
	Fast flash(0.1s/0.1s)	Charging
	Flash(0.5s/0.5s)	Equal or Boost Charging
	Slow flash(0.5s/2s)	Float Charging, Lithium constant voltage charge
Yellow LED	Off	Over voltage protection
	On	On Battery is normal
	Slow flash(0.5s/2s)	Battery voltage is low
Red LED	Fast flash(0.1s/0.1s)	Low voltage protection
	Off	Work normal (Standard version)
	On	The output power is 0
	Super slow(0.2s/5s)	Open circuit protection
	Flash(0.5s/0.5s)	Over temperature
	Fast flash(0.1s/0.1s)	Short circuit or Over current protection

MPPT Charge Controller Specifications					
Battery Parameters	System Voltage	12V	12V/24V	12V/24V	12V/24V
	Max Charging Current	8A	10A	15A	20A
	Battery Type	Lithium			
	Charging Volt. Target	10.0-17.0V (Programmable, default:12.6V)	10.0-32.0V(Programmable, default: 12.6V)		
	Charging Volt. Recovery	9.2-16.8V (Programmable, default:12.4V)	9.2-31.8V(Programmable, default: 12.4V)		
	Low voltage disconnect	9.0-15.0V (Programmable, default:9.8V)	9.0-30.0V(Programmable, default: 9.0V)		
	Low voltage reconnect	9.6-16.0V (Programmable, default:9.8V)	9.6-31.0V (Programmable, default: 9.8V)		
	0°C Charging protection	Yes, Slow, No(Programmable)			
Panel Parameters	Max volt on PV terminal	60V		55V	55V
	Max input power	100W-120W	130W/260W	200W/400W	260W/520W
	Dusk/Dawn detect volt.	3.0-8.0V (Programmable)	3.0-20.0V (Programmable)		
	Day/Night delay time	0-30min (Programmable)	0-30min (Programmable)		
	MPPT tracking range	(Battery Voltage +1.0V) -Voc×0.9			
Load Parameters	Output Power	1-60W	10-60W/20-120W	10-90W/20-180W	
	Output Voltage	20 - 55V	15-60V/35-60V	20-55V/30-55V	
	Current setting range	0.15-3.0A (Programmable)	0.15-4.0A (Programmable)	0.15-6.0A (Programmable)	
	Min current	100mA (Dimming)			
	Current precision	±2%			
	Dimming	0-100% (Programmable)			
	Voltage of start dimming	10.0-17.0V(Lithium)	10.0-32.0V(Lithium)		
	Dimming percentage	1-20% (Programmable)			
System Parameters	Max tracking efficiency	>99.9%			
	Max charge conversion	97.50%			
	Max LED driver efficiency	96%			
	Communication mode	Infrared/2.4G/RS485			
	Induction mode	Infrared Human Sensing/Microwave Sensing			
	Self consumption	6-25mA			
	Ambient temperature	-31-+140 F°			
	Ambient humidity	0-100%RH			
	Protection degree	IP 67			
	Max Altitude	4000m			

### Smart IoT Solar Lighting Management



The integrated smart control system combines advanced solar lighting technology with IoT-enabled wireless communication, providing real-time monitoring and remote management of every lighting asset. Through a secure cloud-based platform, operators can continuously monitor the performance and operating status of key system components—including the luminaire, solar panel, battery, and controller. This intelligent system allows users to remotely control lighting schedules, adjust brightness levels, and verify operational status across entire lighting networks from any computer or mobile device. Real-time alerts and performance data enable proactive maintenance and improved system reliability, reducing operational costs and ensuring consistent lighting performance.

Multiple lighting profiles can be programmed based on time of day, traffic activity, or site-specific requirements, allowing lights to automatically adjust output levels to maximize energy efficiency and extend battery autonomy. The system architecture includes single-light controllers, centralized communication gateways, and a cloud-based smart management platform. Each luminaire transmits operational data through a wireless network to the cloud, enabling centralized monitoring, analytics, and remote control across large-scale lighting deployments.

This smart infrastructure transforms traditional lighting into a connected, data-driven asset, improving reliability, reducing maintenance costs, and enabling smarter management of public and commercial lighting networks.

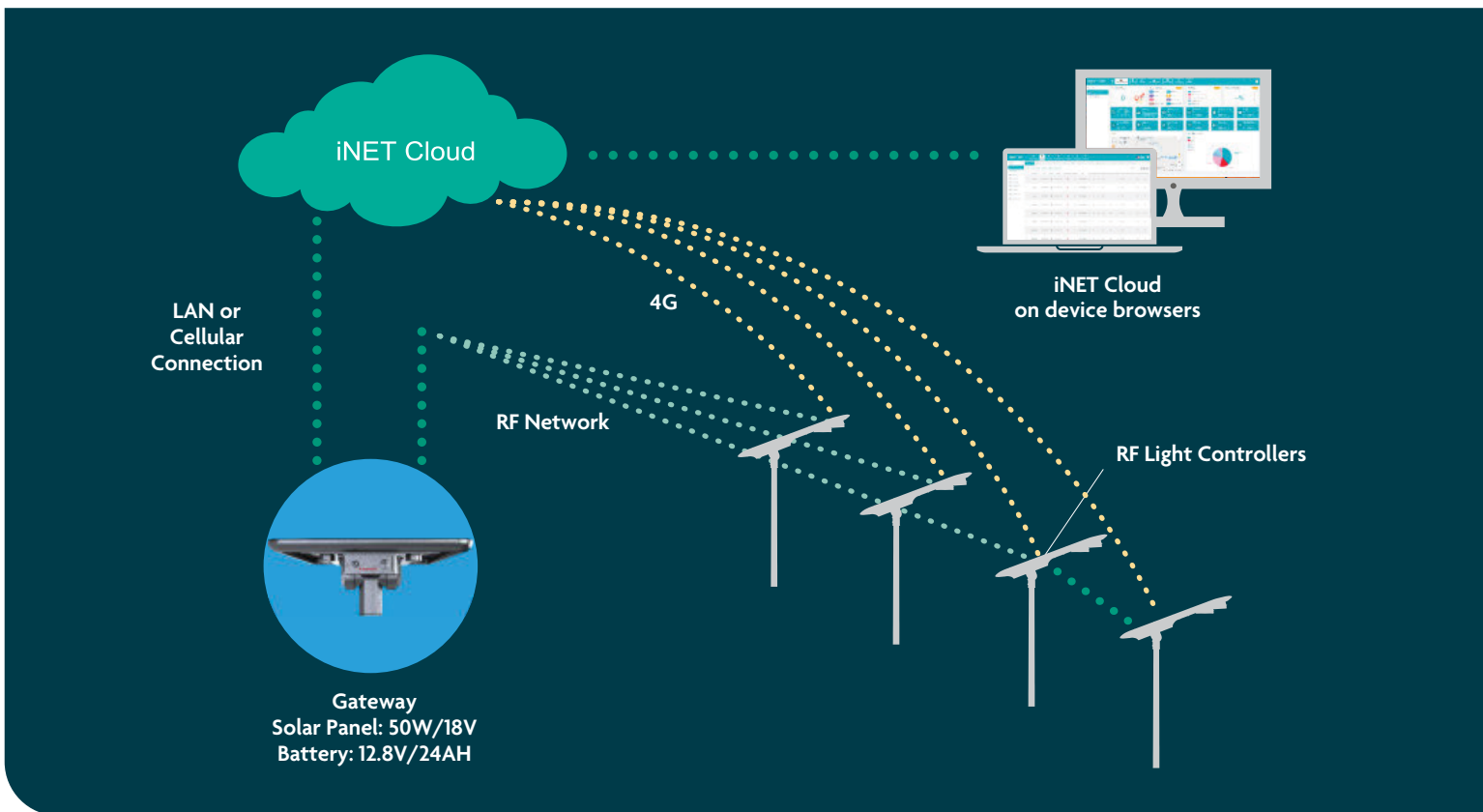

### System & Hardware

---



#### Automatic Light On/Off & Dimming Control

- By time setting
- On/Off or dimming with motion sensor detection
- On/Off or dimming with photocell detection

#### Accurate Operation & Fault Monitor

- Real-time monitor on each fixture working status
- Accurate report on fault detected
- Provide location of fault, no patrol required
- Collect operation data, such as voltage and power consumption



#### Extra I/O Ports for Sensor Expandability

- Environment Monitor
- Traffic Monitor
- Security Surveillance
- Seismic Activities Monitor

#### Reliable Mesh Network

- Self proprietary wireless control mode
- Reliable node to node, gateway to node communication
- Up to 1000 nodes per network
- Maximum network diameter 6,561 ft



#### Easy-to-use Platform

- Easy monitor on each and all lights status
  - Support lightning policy remote set-up
  - Cloud server accessible from computer or hand held device
-

### Installations Notes

---

**1.** Due to variations in longitude and latitude at the installation site, the angle at which the sun's rays illuminate differs. During installation, it is crucial for the solar panel to be oriented towards the sun precisely at 12:00 noon. However, often due to factors like road direction and light poles, achieving this alignment becomes challenging. The solar panel must still maintain a horizontal position even if it can't be ideally oriented towards the sun at noon due to road lighting requirements.

Several conditions can lead to suboptimal functioning of standard lamps. Prior to making a purchase, it's important to communicate these factors to the salesperson and consider increasing the solar panel's power capacity:

- a. Any deviation below the horizontal plane of the solar panel, relative to the solar irradiation angle, will result in a significant decline in the solar panel's power generation efficiency.
- b. When installing solar lamps and lanterns, it's essential to avoid any obstacles that might block sunlight, such as trees or buildings.
- c. Natural elements like rain, ice, snow, dust, clouds, and bird droppings can reduce the solar panel's power generation efficiency. Ensuring that the solar panel remains unobstructed by barriers like trees and buildings, and accounting for factors such as the solar panel's angle and external elements, are vital for optimal performance.

**2.** Install lamps at a considerable distance from areas prone to strong electromagnetic interference, such as high-voltage cables and high-power wireless transmission towers. These sources could potentially disrupt the lamp control system, leading to malfunctions and improper operation.

**3.** When the temperature drops below 0°, the efficiency of lithium iron phosphate batteries for charge and discharge decreases. To prevent damage and the battery protection triggered by overdischarge, it's advisable to explain this to the sales staff and consider increasing battery capacity before making a purchase.

**4.** Any environmental impact can result in a decline in the efficiency of solar panel power generation. Repeated discharge of the lithium iron phosphate battery might easily activate the protection mechanism, causing the lamps to stop functioning normally. Most lithium batteries can be restored to operation by disconnecting and reconnecting the battery-light source connection and the solar panel connection.

**5.** Once the battery protection has been deactivated and reactivated, our focus should be on identifying and resolving any natural environmental factors that compromise the efficiency of solar panel power generation, as well as minimizing the power consumption of the light source.

**6.** Install the lamps on days abundant with sunshine. The lamps are initially set to 30% power upon leaving the factory. Prior to installation and usage, ensure that the lamps can receive effective sunlight charging for at least 4 hours after activation. Failure to do so may trigger battery startup stress protection due to excessive discharge, leading to abnormal lamp operation.

**7.** The self-discharge and stress protection features of the lithium iron phosphate battery necessitate that if the lamp remains unused and uninstalled for a period of 60 to 90 days from the factory departure, it must undergo a 4-hour effective sun charging upon activation.

Instances where lamp functionality is compromised due to the aforementioned circumstances are not included in the warranty coverage. However, we are committed to assisting customers in identifying and analyzing the underlying causes, and devising plans for enhancements. It's important to note that lamps unable to activate after battery protection will not be covered by the warranty.

